

INSTRUCTION MANUAL

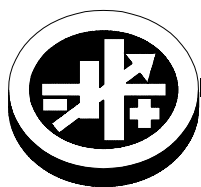

KEPCO An ISO 9001 Company.



50 WATT SINGLE OUTPUT, PFC, OPEN FRAME POWER SUPPLIES

I — INTRODUCTION

SCOPE OF MANUAL. This instruction manual covers the installation and operation of the Kepco RTW 50W Series of Open Frame PFC (Power Factor Corrected) Switching Power Supplies.

DESCRIPTION. The Kepco RTW 50W Series consists of seven models of switching power supplies, with a single output as shown in Table 1. Units may be operated with a nominal 100 to 120V a-c and 220 to 240V a-c (input voltage range 85 to 265 Va-c), 50-60 Hz (input frequency range 47-440Hz.). They will also operate on 110V to 370V d-c input. The RTW 50W Series employs a forward converter with a fixed switching frequency of 190KHz. Power Factor Correction (PFC) is provided by a boost converter. Regulation is provided by pulse width modulation. A thermistor circuit prevents excessive turn-on current surge. Remote on-off and remote programming of output voltage using an external resistance can be implemented. Overvoltage and overcurrent protection is provided. Current limiting with automatic recovery from short circuit is featured. Units are convection cooled L-chassis construction. A steel cover (Model CA 37) is available as an option.

Section II contains specifications and operating limits of individual RTW 100W Series models (Table 1) as well as specifications and operating limits common to all RTW 100W Series Models. Section III describes installation and Section IV describes operation

II — SPECIFICATIONS

The following specifications are at rated input voltages at 25°C unless otherwise specified.

TABLE 1. OUTPUT RATINGS AND SPECIFICATIONS, RTW 100W SERIES

MODEL	RTW 3.3-12K	RTW 5-10K	RTW 12-4.3K	RTW 15-3.5K	RTW 24-2.2K	RTW 28-1.8K	RTW 48-1.1K
OUTPUT VOLTAGE SETTING, d-c	3.3 ±0.03V	5 ±0.05V	12 ±0.12V	15 ±0.15V	24 ±0.24V	28 ±0.28V	48 ±0.48V
ADJUSTMENT RANGE, Vd-c	2.60-4.0	4.0-5.8	9.6-13.2	12-16.5	19.2-26.4	22.4-30.8	38.4-52.8
OUTPUT CURRENT, MAX (AMPS)	12.5	10	4.3	3.5	2.2	1.8	1.1
OUTPUT POWER, MAX ⁽³⁾ (WATTS)	41.2	50	51.6	52.5	52.8	50.4	52.8
OVP SETTING ⁽¹⁾ (VOLTS)	4.2-5.2	6.0-6.9	13.7-15.7	17.0-19.0	27.0-30.5	32.0-35.0	55.0-60.0
OVERCURRENT SETTING ⁽²⁾ (AMPERES)	10.5-12.5	10.5-12.5	4.5-5.4	3.68-4.38	2.3-2.75	1.9-2.25	1.15-1.38
SHORT CIRCUIT CURRENT (AMPERES) (typ)	15.5	13	5.6	4.5	3.0	2.5	1.7
EFFICIENCY	100 Va-c	75%	80%	81%	82%	82%	82%
	240 Va-c	77%	82%	83%	85%	85%	85%
RIPPLE AND NOISE ⁽⁴⁾ (mV p-p)	Switching ripple (typ)	80	80	100	100	150	200
	spike noise (typ) ⁽⁴⁾	120	120	150	150	200	300
External Potentiometer ⁽⁵⁾	250 Ohms	250 Ohms	500 Ohms	500 Ohms	1K Ohms	1K Ohms	2K Ohms

(1) An overvoltage shuts down the output. Recover by recycling a-c input (30 second delay required before resetting).

(2) Square type. After the cause of overcurrent is removed, output voltage recovers automatically.

(3) See Figure 1 for temperature and input voltage rating.

(4) Bandwidth 100MHz. Ripple and noise will be approximately 1.5 times these values in the operating temperature range -10 ~ 0°C. The ripple and noise values tabulated are valid when the output is derated as shown in figure 1 from 40 ~ 71°C.

(5) Used for remote programming of output voltage. See Section IV OPERATION, REMOTE VOLTAGE PROGRAMMING.

INPUT VOLTAGE:

Nominal 100-120V a-c, 220-240V a-c, range: 85-265V a-c (0 to 100% load, -10 to 71°C); d-c range: 110 -370V d-c.

INPUT SOURCE FREQUENCY:

Nominal 50/60 Hz; Range 47-66 Hz (0 to 100% load, -10 to 71°C). (Above 66Hz to 440 Hz the leakage current exceeds the VDE safety specification limit.)

INPUT CURRENT:

0.7A rms max. (100-120 Va-c input, 100% load); 0.4A rms max. (200-240 Va-c input, 100% load).

3.3V model: 0.6A rms max. (100-120 Va-c input, 100% load); 0.3A rms max. (200-240 Va-c input, 100% load).

INPUT PROTECTION AND SOFT START: A thermistor circuit reduces start-up surge. Units are protected against shorts by an input fuse. Fuse value 2A, 250V.

INPUT SURGE: cold start 25 °C (First surge only, not including the current flow into the EMI filter)

14A typ. (100 V a-c, 100% load); 28A typ. (200 Va-c, 100% load).

KEPCO, INC. • 131-38 SANFORD AVENUE • FLUSHING, NY. 11352 U.S.A. • TEL (718) 461-7000 • FAX (718) 767-1102

http://www.kepcopower.com • email: hq@kepcopower.com

LEAKAGE CURRENT:

0.28mA typ, 0.45mA max at 100V a-c and 60 Hz (operating in conformance with Den-An),
0.38mA typ, 0.6mA max at 240V d-c and 60 Hz (operating in conformance with IEC 950 and UL1950).

POWER FACTOR: 0.99 typ. at 100 Va-c, 0.94 typ. at 200 Va-c.

STABILIZATION:

Source Effect: (85 to 132Va-c, 170-265 Va-c) 0.1% typ., 0.2% max.
Load Effect: (0% - 100% of rated output current) 0.2% typ., 0.4% max.
Temperature effect: (-10 to 71°C) 0.5% typ., 1.0% max.
Combined effect (source, load, temperature): 0.9% typ., 1.8% max.
Time effect (drift): (1/2 to 8 hr. at 25°C) 0.2% typ., 0.5% max.

TRANSIENT RECOVERY: A step load change from 50% to 100% of rated output current in 50 microseconds or more, produces no more than 4% output voltage excursion. Recovery time is 1ms maximum.

ACCEPTABLE LOAD CAPACITANCE: 10,000µF max (start-up time is affected)

OUTPUT HOLDING TIME: Upon input interruption, output maintained for 30ms typ. (20ms min.). 3.3V model: 55ms typ., 40ms min. 48V model: 35ms typ., 25ms min.

START UP TIME: 400ms typ., 500ms max. at 100 Va-c; 200ms typ., 300ms max., at 240 Va-c. Between 0 and -20° C output may take 3 seconds to stabilize.

OVERVOLTAGE PROTECTION: Fixed, factory set. See Table 1. The overvoltage circuit is set by Zener diode clamp, latching will occur.

OVERCURRENT: Square type, output voltage returns to rated level upon removal of cause of malfunction.

OPERATING TEMPERATURE: -10 to 71°C (start up -20 to -10°C). See the derating, Figure 1. Do not allow the power supply to become dust covered because that will decrease the cooling efficiency of the unit and cause insulation to deteriorate.

STORAGE TEMPERATURE: -30°C to + 75°C.

COOLING: Natural convection.

ORIENTATION: Vertical or horizontal (see Figure 4).

HUMIDITY: Operating: 10% to 95% relative humidity, storage:10% to 95% relative humidity; noncondensing, wet bulb temperature < or = 35°C.

WITHSTANDING VOLTAGE

(at 15 to 35°C ambient, 10 to 85% relative humidity):
Between input and output terminals, 3.0 KV a-c for 1 minute, cutout current 10 ma.
Between input terminals and ground, 2.0 KV a-c for 1 minute, cutout current 10 ma.
Between output terminals and ground, 500V a-c for 1 minute, cutout current 20 ma.

INSULATION RESISTANCE: Between input and output, input and ground, output and ground, 100 megohms minimum (500V d-c, 15 to 35°C ambient, 10 to 85% relative humidity).

VIBRATION: Three axes, one hour each, sweep time 10 min.; nonoperating
5-10 Hz., 10 mm amplitude.
10-200 Hz., 2G (19.6m/s2) acceleration.

SHOCK: Three axes, 20G (196m/s2) when installed per Figure 4, method A, 60G (588m/s2) when installed per Figure 4, method B or C, 11ms ±5 msec pulse duration, three shocks each axis, nonoperating, 1/2 sine pulse.

EMC - EMISSIONS:

Radiated Noise 30MHZ to 1GHZ: FCC Class B, VCCI-B, EN55011-B, EN55022-B
Conducted Noise 0.15MHZ to 30MHZ: FCC Class B, VCCI-B, EN55011-B, EN55022-B
Input Harmonics (on AC Mains) 0 to 2KHZ: EN 61000-3-2.

EMC - IMMUNITY: Designed to meet EN 50082-2.

ESD: EN 61000-4-2 Level 4, Normal operation.
Radiated Field Noise: EN 61000-4-3 Level 3, Normal operation.
Electrical Fast Transient/Burst (EFT): EN 61000-4-4 Level 3, Normal operation.
Surge: EN 61000-4-5 Level 4, no damage.
Conducted Noise: EN 61000-4-6 Level 3, Normal operation.
Power Frequency Magnetic Field: EN 61000-4-8 Level 4, Normal operation.
Voltage Dips, Short Interruptions, Voltage Variation: EN 61000-4-11, Normal operation.

SAFETY: All units designed to meet EN 60950:2001 Assistance for DEN-AN. U.S. UL 60950 First Edition.; Canada: CSA-22.2 No. 60950-1. (ambient temp. 50°C max.). RTW 100W units are CE marked per the Low Voltage Directive (LVD), EN60950 73/23/EEC AND 93/68/EEC. [The standards do not apply with DC input operation.]

WEIGHT: 8.82 oz. (250 grams) max

WARRANTY: One year.

KEPCO, INC. • 131-38 SANFORD AVENUE • FLUSHING, NY. 11352 U.S.A. • TEL (718) 461-7000 • FAX (718) 767-1102

<http://www.kepcopower.com> • email: hq@kepcopower.com

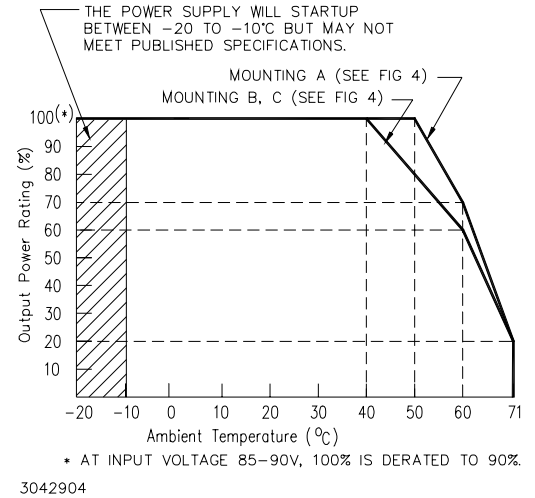

FIGURE 1. OUTPUT POWER VS. TEMPERATURE

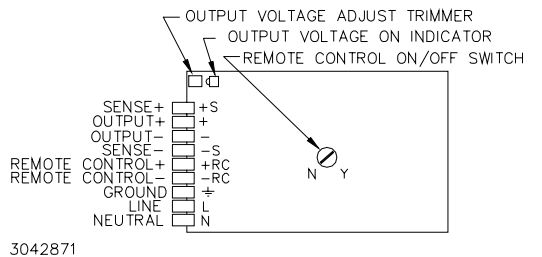

FIGURE 2. COMPONENT LOCATIONS

III — INSTALLATION

MOUNTING THE POWER SUPPLY: Refer to Figures 4 and 5. The unit may be mounted on one mounting surface. Note the restrictions for maximum penetration of mounting screws. The air temperature surrounding the power supply must not exceed the ambient values given in the graph in Figure 1.

CONNECTIONS: Connect the load to the power supply as shown in Figure 3. The unit is shipped with shorting links in place for Local sensing. The AC input power is applied via the terminal block. Make sure to connect the AC input Neutral, Line and Ground wires to the respective terminals of the terminal block (see Figure 2). **Sensing (either Local or Remote) MUST be used.**

LOCAL/REMOTE SENSING: Figure 3 shows proper connection of multiple loads using either remote or local sensing. **If local or remote sensing is not configured, the unit will not work properly.** The unit is shipped with shorting links in place for Local sensing. For remote sensing, remove the shorting links and connect the +S and -S terminals to the load. Remote sensing compensation is up to 0.4V per load wire (0.15V for RTW 3.3-12K, 0.25V for RTW 5-10K). Transient recovery specs may not be met when remote sensing is used. If oscillations set off overvoltage protection, install one electrolytic capacitor (470mF min) between +S and + and one between - and -S terminals.

IV — OPERATION

When output voltage is available, the green LED is on. The Output Voltage Adjust trimmer (see Figure 2) allows adjustment of the output voltage within the range specified in Table 1.

REMOTE ON OFF: Use ±RC terminals to set output on or off after setting the Remote On/Off switch to Y (see Figure 2). Output OFF requires no voltage, or short circuit, or 0 to 0.8V across ±RC terminals; Output ON requires 4.5 to 12.5V (or 12.5 to 24.5V through 1.5K Ohms) across ±RC terminals. ±RC terminals are isolated from AC input and DC output terminals.

REMOTE VOLTAGE PROGRAMMING: In addition to the integral trimmer, output voltage can be also be adjusted via an external variable resistance (see Figure 3). The variable resistance specified in Table 1 must be substituted for the shorting link between + and +S terminals.

SERIES OPERATION: When a number of power supplies are operating in series, the current rating is to be limited to the rating of the power supply with the lowest rating. A diode ($V_r > 2 \sum V_o$, $I_f > 2 I_o$, $V_f \ll \text{low}$) must be connected to the power supply output terminals to protect the unit from reverse voltage.

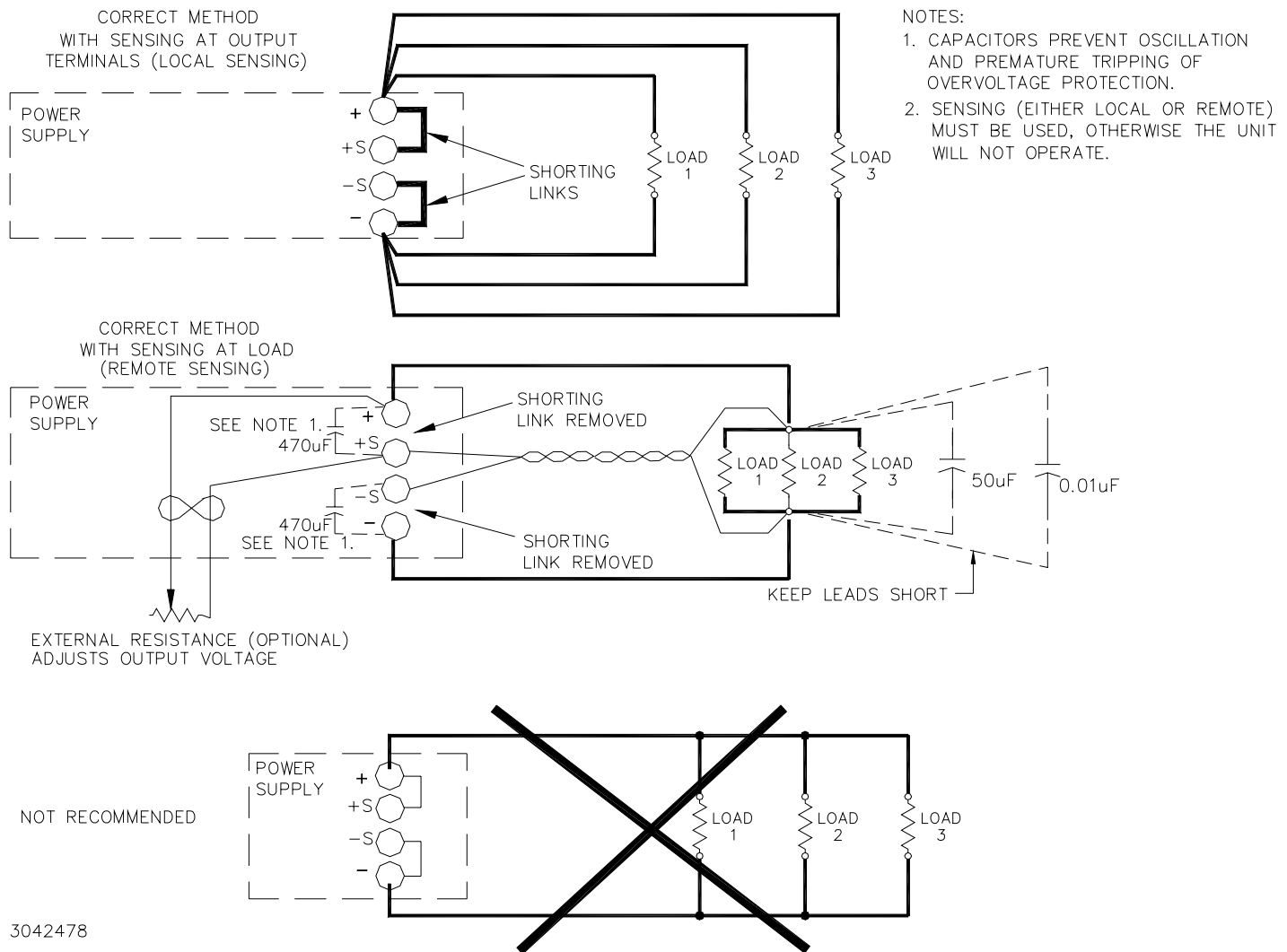
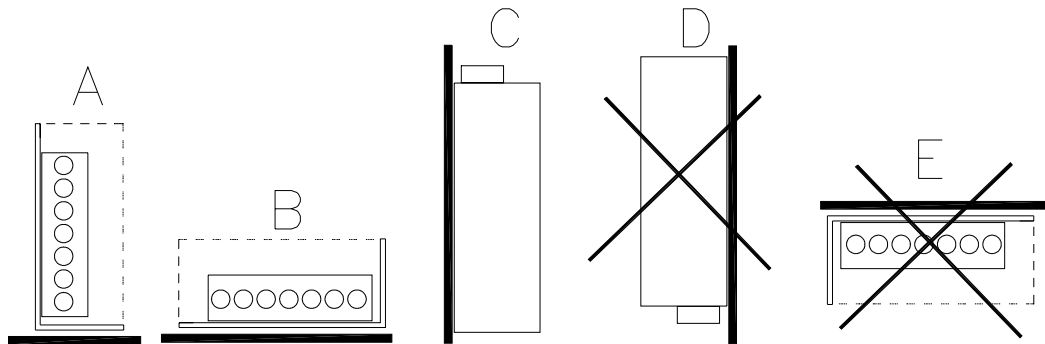

FIGURE 3. LOAD CONNECTIONS



NOTES:
 1. METHODS D AND E ARE NOT RECOMMENDED DUE TO INSUFFICIENT VENTILATION.
 2. REFER TO FIGURE 1 FOR OUTPUT POWER VS. TEMPERATURE FOR MOUNTING METHOD SELECTED.

3042479

FIGURE 4. POWER SUPPLY MOUNTING

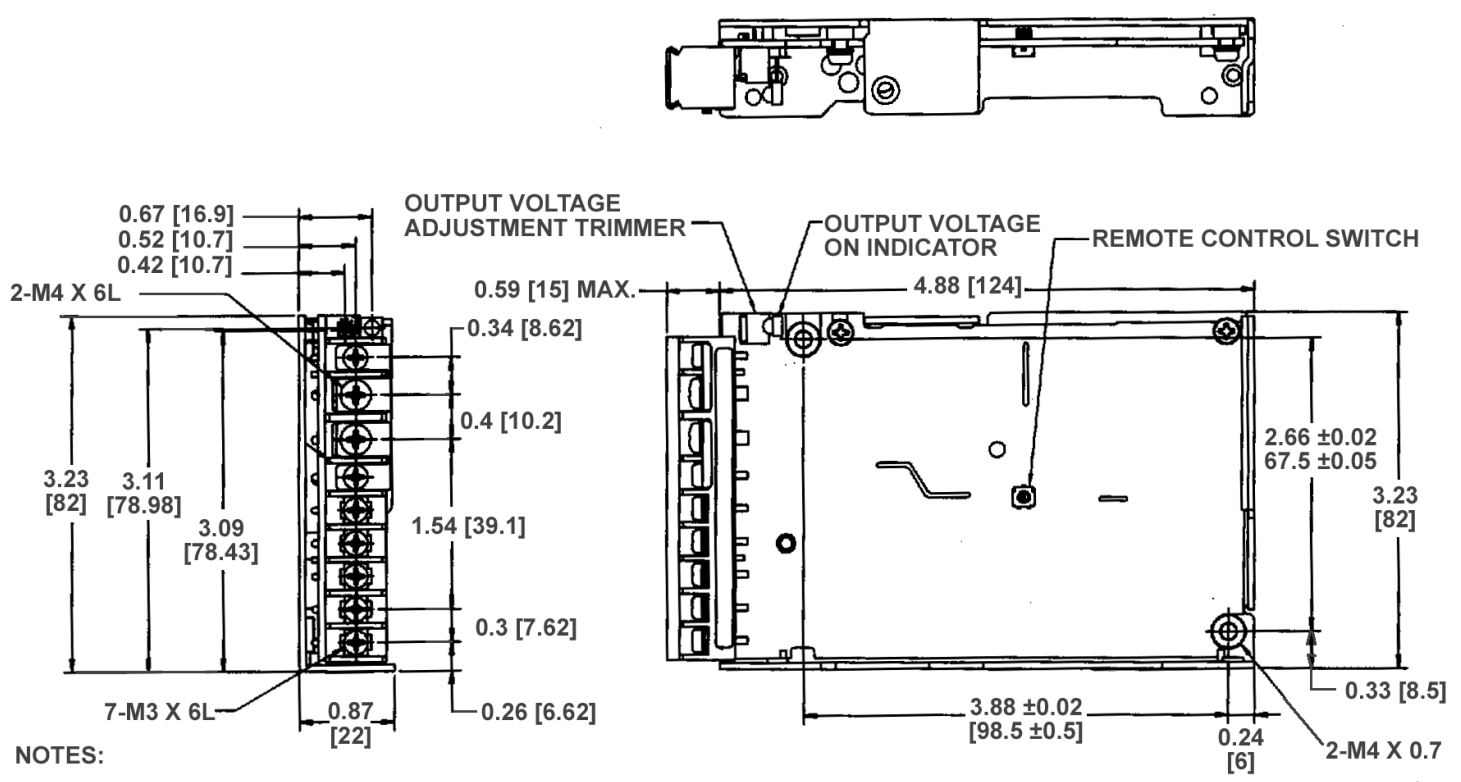

NOTES:
 1. MAX PENETRATION OF M4 MOUNTING SCREWS IS 0.024 [6] FROM CASE SURFACE.
 2. ± 0.04 [± 1] TOLERANCE UNLESS OTHERWISE SPECIFIED.
 3. DIMENSIONS ARE IN INCHES. DIMENSIONS IN BRACKETS ARE IN MILLIMETERS.
 4. REFER TO FIGURE 4 FOR MOUNTING ORIENTATION.

3010270

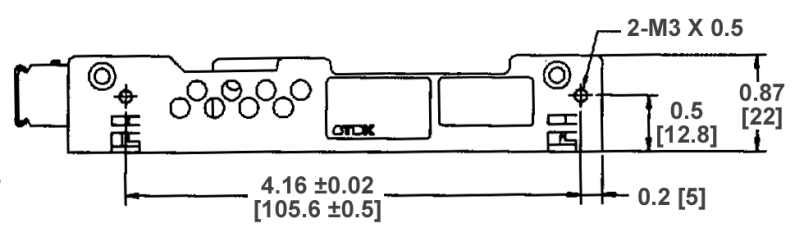

FIGURE 5. RTW 50W MECHANICAL OUTLINE DIAGRAM